

Table Top Rack Cabinets (RCHS Series) - *HEAVY DUTY*















Textured - Light Gray (RAL7035)

Features:









- Heavy duty, 16-gauge steel, 19" table top rack cabinet...
- For ventilated versions link to our [RCHV series](#)...
- Panel rails are infinitely adjustable (front to back), round hole punched for 10-32 clip-nuts to full EIA hole centers (5/8 - 5/8 - 1/2 inch spacing)...
- Includes two pairs of rails (for rear support of heavier equipment), rubber feet, black ABS plastic handles, a starter pack of 10-32 clip nuts & matching **1421ABK** black screws...
- Supplied unassembled (four cabinet pieces & four rails), shipped in a flat pack container for handling ease & protection (see photo below)...
- Simple assembly using one bolt in each corner to lock the sides to the top and bottom (hardware included)...
- Overall width 21"...
- Overall height 2" over panel space...
- Front & back lip is .585" so usable depth is reduced by 1.17"
- Recommended maximum weight (RCHS1902824 tested) - 800 pounds...
- Rugged textured powder paint finish...
- Stocked in Black & Light Gray (RAL7035)...



17.5" Deep models:













| Part Number | Color |  Reader File | AutoCAD .dxf File (zipped) | Panel Height | | Number of Clip Nuts Included | Wt. lbs. |
|---|------------------------------|--|---|--------------|-------|------------------------------|----------|
| | | | | Inches | Units | | |
| RCHS1900817BK1 RCHS1900817CG1 RCHS1900817LG1 | Black Beige Light Gray |  63K |  59K | 8.75 | 5 | 8 | 38 |
| RCHS1901017BK1 RCHS1901017CG1 RCHS1901017LG1 | Black Beige Light Gray |  60K |  61K | 10.50 | 6 | 16 | 40 |
| RCHS1901417BK1 RCHS1901417CG1 RCHS1901417LG1 | Black Beige Light Gray |  64K |  60K | 14.00 | 8 | 16 | 44 |
| RCHS1901717BK1 RCHS1901717CG1 RCHS1901717LG1 | Black Beige Light Gray |  67K |  63K | 17.50 | 10 | 16 | 50 |
| RCHS1902217BK1 RCHS1902217CG1 RCHS1902217LG1 | Black Beige Light Gray |  70K |  65K | 22.75 | 13 | 16 | 54 |
| RCHS1902817BK1 RCHS1902817CG1 RCHS1902817LG1 | Black Beige Light Gray |  72K |  67K | 28.00 | 16 | 16 | 60 |

24.5" Deep models:



| Part Number | Color |  Reader File | AutoCAD .dxf File (zipped) | Panel Height | | Number of Clip Nuts Included | Wt. lbs. |
|---|------------------------------|---|---|--------------|-------|------------------------------|----------|
| | | | | Inches | Units | | |
| RCHS1901024BK1 RCHS1901024CG1 RCHS1901024LG1 | Black Beige Light Gray |  68K |  60K | 10.50 | 6 | 16 | 52 |
| RCHS1901424BK1 RCHS1901424CG1 RCHS1901424LG1 | Black Beige Light Gray |  64K |  60K | 14.00 | 8 | 16 | 58 |
| RCHS1901724BK1 RCHS1901724CG1 RCHS1901724LG1 | Black Beige Light Gray |  64K |  60K | 17.50 | 10 | 16 | 62 |
| RCHS1902224BK1 RCHS1902224CG1 RCHS1902224LG1 | Black Beige Light Gray |  66K |  60K | 22.75 | 13 | 16 | 70 |

| | | | | | | | |
|-----------------------|-------------------|--|--|--------------|----|----|----|
| RCHS1902824BK1 | Black |  |  | 28.00 | 16 | 16 | 78 |
| RCHS1902824CG1 | Beige | | | | | | |
| RCHS1902824LG1 | Light Gray | 82K | 60K | | | | |

31.5" Deep models:

| Part Number | Color |  Reader File | AutoCAD .dxf File (zipped) | Panel Height | | Number of Clip Nuts Included | Wt. lbs. |
|--|-----------------------------------|---|--|--------------|-------|------------------------------|----------|
| | | | | Inches | Units | | |
| RCHS1901031BK1 RCHS1901031LG1 | Black Light Gray |  62K |  54K | 10.50 | 6 | 16 | 64 |
| RCHS1901431BK1 RCHS1901431LG1 | Black Light Gray |  63K |  54K | 14.00 | 8 | 16 | 68 |
| RCHS1901731BK1 RCHS1901731LG1 | Black Light Gray |  63K |  53K | 17.50 | 10 | 16 | 74 |
| RCHS1902231BK1 RCHS1902231LG1 | Black Light Gray |  65K |  53K | 22.75 | 13 | 16 | 86 |
| RCHS1902831BK1 RCHS1902831LG1 | Black Light Gray |  66K |  54K | 28.00 | 16 | 16 | 94 |

Feature Views:

| | |
|---|--|
| <p>Ships Flat For Handling Ease & Protection</p> | <p>Interior View With Infinitely Adjustable Panel Rails</p> |
|  <p>Wood Ends</p> <p>Corner protectors nailed to wood ends</p> <p>Banded</p> |  <p>Rails are infinitely adjustable (front to back) on anvil struts</p> <p>Base punched for easy caster mounting</p> |
| <p>Panel Rails (Two Pair Included) With 10-32 Black Clip Nuts & Mounting Hardware</p> | |



Accessories:



Casters - Part Number **1425PHD**













- **SOLD IN A SET OF 4**
- Base of cabinet is punched to accept this caster set
- 600# Mfg's specified weight capacity (Set of 4)
- Features ball bearing swivel and hard composition wheels
- Small foot print 2.125" x 15/16" hole mounting pattern
- Wheels are grey & 2" wheel diameter (adds only 2.5" to overall rack height).
- Includes mounting hardware



Doors

- 16-gauge steel construction
- Both front & back of "RCHS" rack cabinets are punched to accept these doors
- Mounts either right or left hand hinge (door & cabinet are symmetrical)
- Includes installed lock and two keys
- Finished in rugged textured powder paint to match RCHS/RCHV enclosures
- Includes mounting hardware

| Part Number | Color | PDF Reader | AutoCAD .dxf File | Use With Cabinet | Wt. lbs. |
|-------------|-------|------------|-------------------|------------------|----------|
| | | | | | |

| | | File | (zipped) | Panel Height | U's |
|---|---------------------------------|---|---|------------------|-----|
| RC HD1908BK1 RC HD1908CG1 RC HD1908LG1 | Black Beige Light Gray |  17K |  17K | 8" (5 U) | 5 |
| RC HD1910BK1 RC HD1910CG1 RC HD1910LG1 | Black Beige Light Gray |  18K |  18K | 10.5" (6 U) | 5 |
| RC HD1914BK1 RC HD1914CG1 RC HD1914LG1 | Black Beige Light Gray |  19K |  20K | 14" (8 U) | 6 |
| RC HD1917BK1 RC HD1917CG1 RC HD1917LG1 | Black Beige Light Gray |  21K |  22K | 17.5" (10 U) | 7 |
| RC HD1922BK1 RC HD1922CG1 RC HD1922LG1 | Black Beige Light Gray |  22K |  24K | 22.75" (13 U) | 9 |
| RC HD1928BK1 RC HD1928CG1 RC HD1928LG1 | Black Beige Light Gray |  24K |  27K | 28" (16 U) | 12 |



Extra Panel Rails

- RCHS rack cabinets ship with two pair - order below for extra mounting capabilities
- **Sold in pairs**
- Finished in rugged black textured powder paint
- Includes amhal strut mounting hardware (black clip nuts are not included)

| Part Number | Use With Cabinet Panel Height |
|-----------------|-------------------------------|
| RCHR1908 | 8" (5 U) |
| RCHR1910 | 10.5" (6 U) |
| RCHR1914 | 14" (8 U) |
| RCHR1917 | 17.5" (10 U) |
| RCHR1922 | 22.75" (13 U) |



Extra Spring Nuts - Part Number **1421SN**

- 1/4 - 20 Strut nut
- 1/4 - 20 x 1/2 bolt
- Used only in our RCHS & RCHV table top rack cabinets - handy for mounting of other equipment to the horizontal struts
- **Sold in packages of 8 (8 spring nuts and 8 bolts) as shown**



Replacement Rubber Feet - Part Number **1421RC24**

- RCHS rack cabinets ship with four feet included - order these for replacement
- **Sold in package of 20**



PART No. RCHS1901031
 for more information visit
www.hammfg.com
 Data subject to change without notice.
 Isometric drawing not to scale.
 Shipped knockdown for handling ease
 & protection.

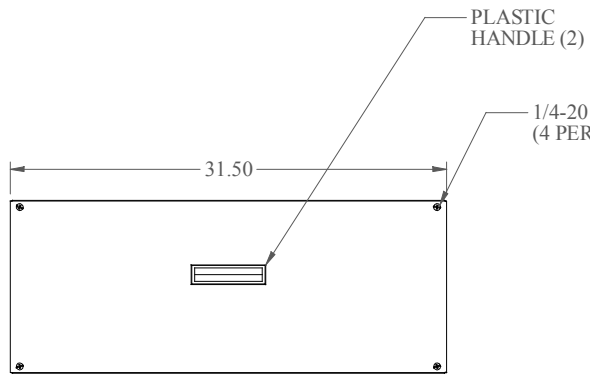

L.S. VIEW

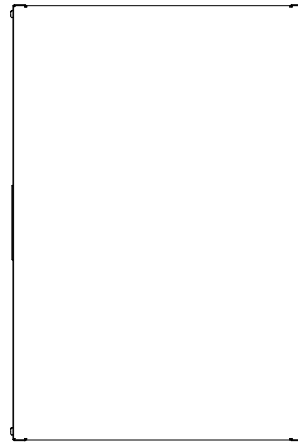

TOP VIEW

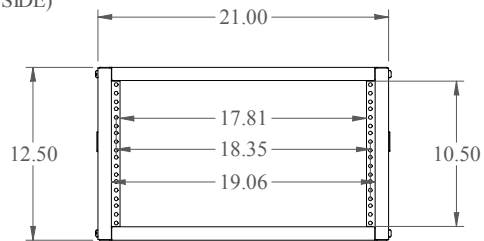

FRONT VIEW

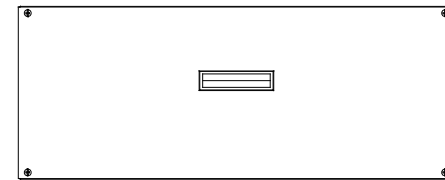
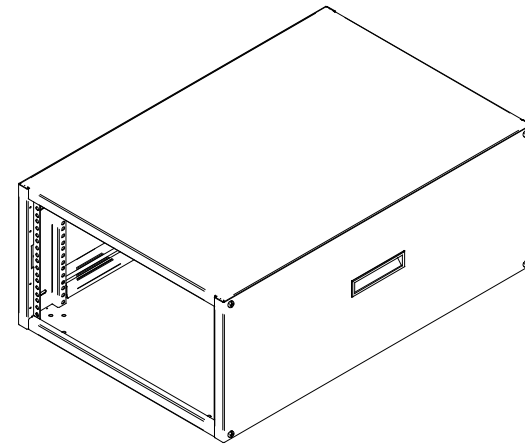

R.S. VIEW

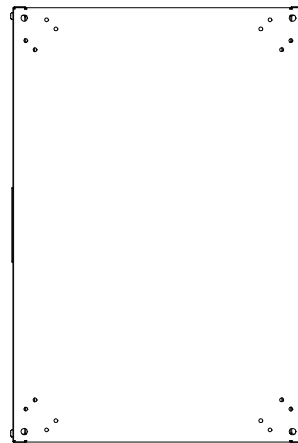

BOTTOM VIEW